

Downlight Specification

K2R55L2

— KING 2 series



【Basic Parameters】

- Material: ADC12, spraying surface
- Driver Installation: Remote
- IP grade: IP20/IP54
- CCT: 2700/3000/3500/4000K/2700-6500K optional
- CRI: 90
- SDCM(Light source): <3 Step
- Beam angle: 15°/24°/36°/45° optional
- UGR(X=4H,Y=8H): ≤8(15°/24°/36°), ≤16(45°)
- Lighting direction: downward
- Dimming method: Non/0-10V/Traic/DALI optional
- Input voltage: AC220-240V
- Working temperature: -15°C-40°C
- Application: Indoor
- Installation: Trimless Recessed
- Certification: CE, UKCA, ROHS, Reach
- Warranty: 5 years



【Frame Color】



White

【Reflector type】



Round



Pin hole



Oval

【Reflector Color】



Matte black



Matte white



Champagne Gold



Mirror



Black chrome

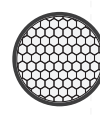

Honeycomb

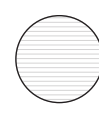

Linear Spread Filter

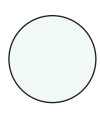

Diffusion Filter

【Product mechanical data】

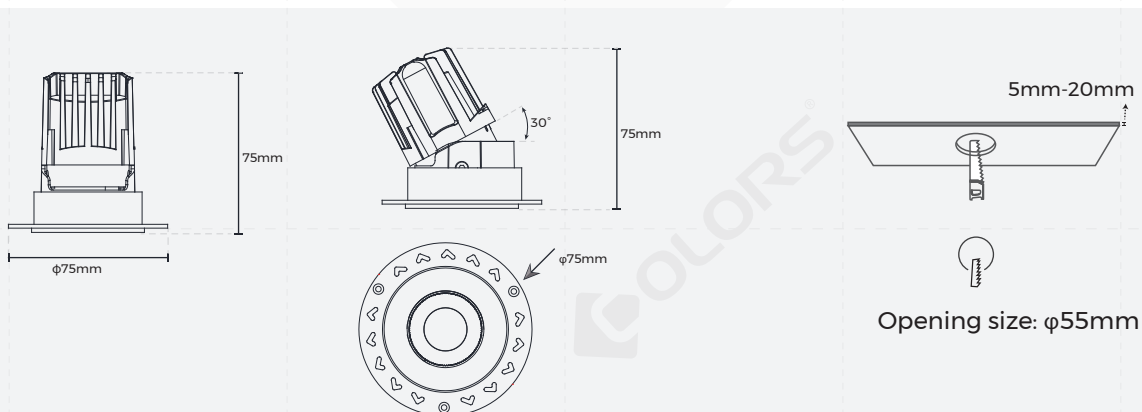

[Luminaire Parameters]

Version	Model	Opening Size (mm)	Input Voltage (V)	Input Current (mA)	Type Power (W)	CRI	Beam Angle	CCT	Lumen (LM)
Normal	K2R55L2	φ55	DC36	150	6	>90	15°	3000K	300
							24°	3000K	440
							36°	3000K	425
							45°	3000K	450
				200	8		15°	3000K	385
							24°	3000K	560
							36°	3000K	545
							45°	3000K	575
				250	10		15°	3000K	450
							24°	3000K	680
							36°	3000K	670
							45°	3000K	700
300	12	15°	3000K	505					
		24°	3000K	805					
		36°	3000K	790					
		45°	3000K	815					
CCT Tunable	K2R55L2	φ55	DC36	200	8	>90	24°	2700K	385
							36°		385
							45°		415
							24°	4000K	480
							36°		480
							45°		505
				24°	6500K		455		
				36°			455		
				45°			480		
				250	10		24°	2700K	460
							36°		460
							45°		480
				24°	4000K		570		
							36°	570	
							45°	600	
24°	6500K	550							
		36°	550						
		45°	580						

CCT Tunable	K2R55L2	φ55	DC36	300	12	>90	24°	2700K	480
							36°		505
							45°		540
							24°	4000K	650
							36°		650
							45°		695
							24°	6500K	600
							36°		625
							45°		650

- Note:
- The above parameters are tested based on the light source with Color Rendering Index Ra90 and 3000K for the Normal version;
Luminous efficiency & luminous flux at 2700K = 3000K value × 0.95
Luminous efficiency & luminous flux at 3500K = 3000K value × 1.03
Luminous efficiency & luminous flux at 4000K = 3000K value × 1.05
 - The input voltage and input current belong to the light source.
 - The brand of the light source is CREE.
 - The power supply brand used is either Egret or Adim.
 - The above parameters belong to the "Round" reflector type, and the light efficiency of the "Pin hole" reflector type and the "Oval" reflector type is 10% lower than that of "Round" reflector type
 - Assembling either honeycomb, Linear Spread Filter and Diffusion Filter will reduce luminous efficacy, UGR and beam angle.
 - Luminous flux is allowed to have a ±10% error range;
 - The above parameters are typical values.

[Optical Parameter]

- Normal

· Type Power:6W

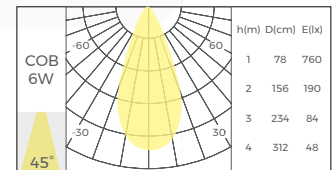
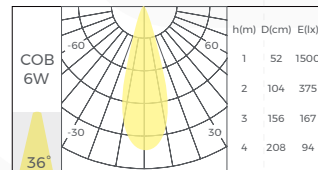
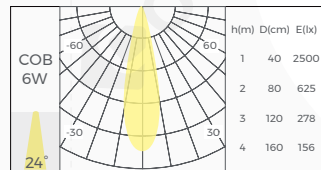
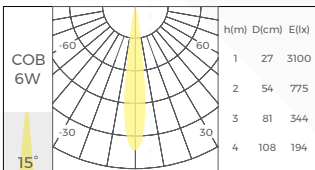

· Type Power:8W

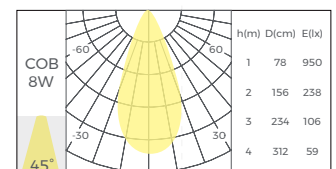
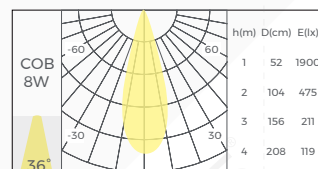
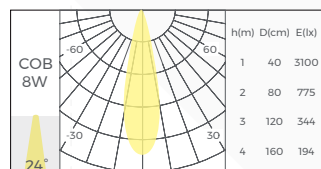
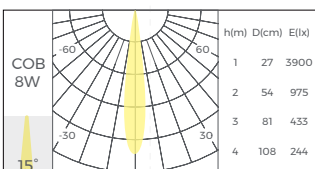

· Type Power:10W

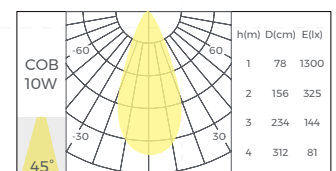
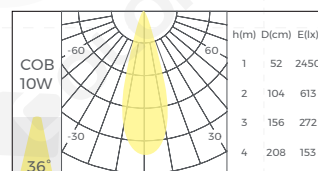
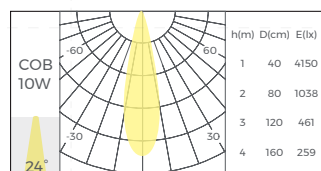
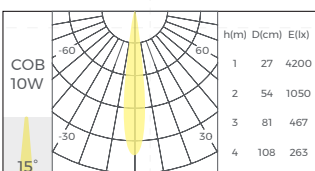

· Type Power:12W

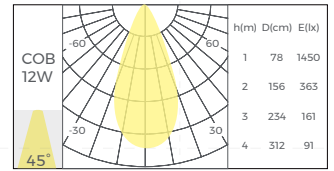
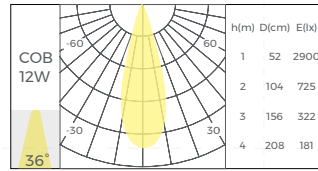
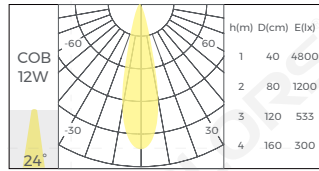
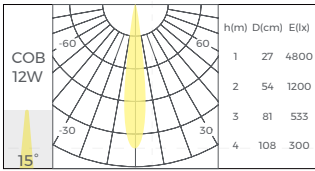

- CCT Tunable

· Type Power:8W

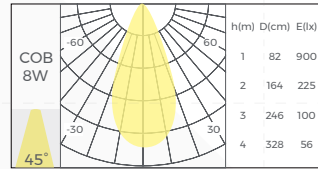
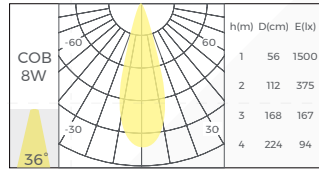
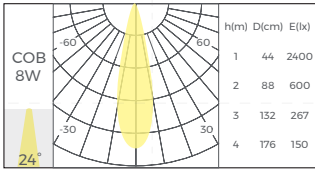

· Type Power:10W

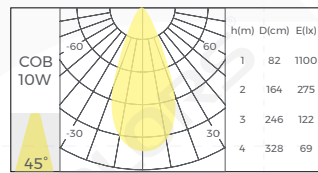
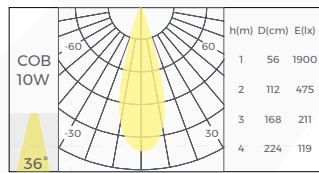
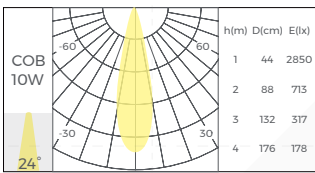

· Type Power:12W

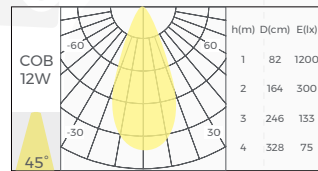
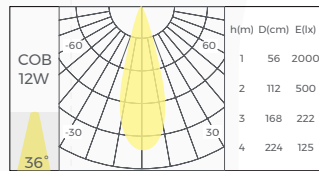
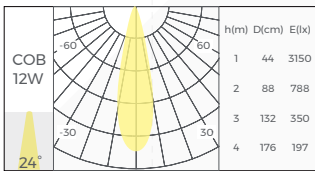

Note:

1. Central light intensity value = 1 meter maximum luminous intensity value;
 1. N meter maximum luminous intensity value = Central light intensity value/N²;
- For example: 2 meter maximum luminous intensity value = Central light intensity value/2²;

[Packing]

Model	Size (mm/box)	Quantity /box	Quantity /carton	NW (kg/box)	NW (kg/carton)	CW (kg)	Size (mm/carton)
DL-K2R55L2-XXX	168*144*100	1	48	0.27	13	19	592*519*422

[Attentions]

1. Non-professionals are prohibited from installing, disassembling and repairing the product.
2. Avoid scratching, distortion and irregular bending of the product during installation; otherwise it may cause irreparable damage to the product.
3. Please use professional cutting tools when cutting
4. Do not use any acid or alkaline adhesive to fix products
5. The product is only suitable for indoor dry places, can not be used in outdoor, seaside or wet environment.